



Axon A4FLEX

AES67 Networked Audio Connectivity Interface



User Manual

Date 2/21/2020

1675 MacArthur Boulevard · Costa Mesa, CA 92626
Ph: 800/854-4079 or 714/957-7100 · Fax: 714/754-6174

© 2020 QSC, LLC all rights reserved. QSC and the QSC logo are registered trademarks of QSC, LLC in the U.S. Patent and Trademark office and other countries. All other trademarks are the property of their respective owners. Patents may apply or be pending.

www.qsc.com

614-00046

IMPORTANT SAFETY INSTRUCTIONS

The symbols below are internationally accepted symbols that warn of potential hazards with electrical products.



This symbol, wherever it appears, alerts you to the presence of un-insulated dangerous voltage inside the enclosure -- voltage that may be sufficient to constitute a risk of shock.



This symbol, wherever it appears, alerts you to important operating and maintenance instructions in the accompanying literature. Please read the manual.

1. Read these instructions.
2. Keep these instructions.
3. Heed all warnings.
4. Follow all instructions.
5. Do not use this apparatus near water.
6. Clean only with a dry cloth.
7. Do not block any ventilation openings. Install in accordance with the manufacturer's instructions.
8. Do not install near any heat sources such as radiators, heat registers, stoves, or other apparatus (including amplifiers) that produce heat.
9. Do not defeat the safety purpose of the polarized or grounding-type plug. A polarized plug has two blades with one wider than the other. A grounding type plug has two blades and third grounding prong. The wider blade or the third prong is provided for your safety. If the provided plug does not fit into your outlet, consult an electrician for replacement of the obsolete outlet.
10. Protect the power cord from being walked on or pinched particularly at plugs, convenience receptacles, and the point where they exit from the apparatus.
11. Only use attachments/accessories specified by Attero Tech
12. Use only with the cart, stand, tripod, bracket, or table specified by the manufacturer, or sold with the apparatus.
13. Unplug this apparatus during lightning storms or when unused for long periods of time.
14. Refer all servicing to qualified service personnel. Servicing is required when the apparatus has been damaged in any way, such as power-supply cord or plug is damaged, liquid has been spilled or objects have fallen into the apparatus, the apparatus has been exposed to rain or moisture, does not operate normally, or has been dropped.
15. When permanently connected, on all-pole mains switch with a contact separation of at least 3mm in each pole shall be incorporated in the electrical installation of the building.
16. If rack mounting, provide adequate ventilation. Equipment may be located above or below this apparatus but some equipment (like large power amplifiers) may cause an unacceptable amount of hum or may generate too much heat and degrade the performance of this apparatus.



TO REDUCE THE RISK OF FIRE OR ELECTRIC SHOCK, DO NOT EXPOSE THIS APPARATUS TO RAIN OR MOISTURE.

WARRANTY INFORMATION

For a copy of the QSC Limited Warranty, visit the QSC website at www.qsc.com

Note: This equipment has been tested and found to comply with the limits for a Class A digital device, pursuant to Part 15 of the FCC Rules and EN55022. These limits are designed to provide reasonable protection against harmful interference when the equipment is operated in a commercial environment. This equipment generates, uses, and can radiate radio frequency energy and, if not installed and used in accordance with the instruction manual, may cause harmful interference to radio communications. Operation of this equipment in a residential area is likely to cause harmful interference, in which case the user will be required to correct the interference at their own expense.





Contents

1 - Overview	1
1.1 - What's in the Box	1
1.2 - Optional Accessories	1
1.3 - Device Features - Front Panel	1
1.4 - Device Features - Rear Panel.....	1
2 Product Installation.....	2
2.1 - Mounting.....	2
2.2 - Power & Network Connectivity	3
2.2.1 - Daisy Chain Switched Configuration.....	3
2.2.2 - Independent VLAN Configuration.....	4
2.3 - Audio I/O Connections	4
2.4 - LED Status Indications.....	5
3 - Device Configuration	5
3.1 - IP Address Setup	5
3.2 - Networking Information	5
3.3 - Audio I/O and DSP Setup.....	6
3.4 - Logic I/O Setup	7
3.5 - Factory Reset	7
3.6 - Firmware Updates	7
4 - ARCHITECTS & ENGINEERS SPECIFICATION	i
Device Specifications.....	ii

1 - Overview



1 - A4FLEX Front and Rear

The Attero Tech by QSC Axon A4FLEX is a compact and scalable mic/line connectivity solution for AES67 networked AVC systems. With four mic/line inputs (two of which are flex I/O and can be configured as outputs instead), USB and AES67 audio and control interfaces, logic inputs and outputs, and a two-channel power amplifier the A4FLEX is equally suited to be the heart of a huddle space, small conference room, or I/O extension to a wide variety of DSP platforms. The A4FLEX can be a key part of conferencing and presentation systems in corporate, higher education, hospitality and courtroom venues.

1.1 - What's in the Box

The A4FLEX comes supplied with the following:

- Axon A4FLEX device
- Euro-block mating plugs
- 1- 6ft Mini USB cable
- Two removable mounting flanges

1.2- Optional Accessories

- 1 RU Rack/Surface Mount Tray Kit

1.3 - Device Features - Front Panel

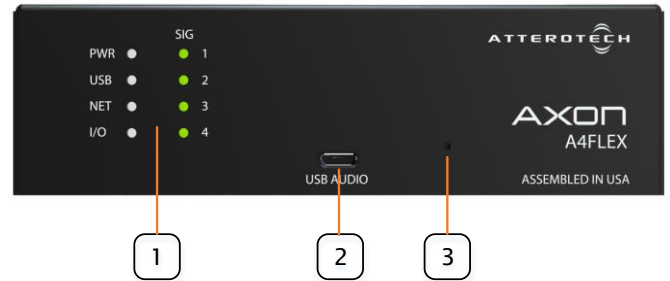

	Description
1	LED status indicators
2	USB audio connection
3	Factory reset access

1.4 - Device Features - Rear Panel

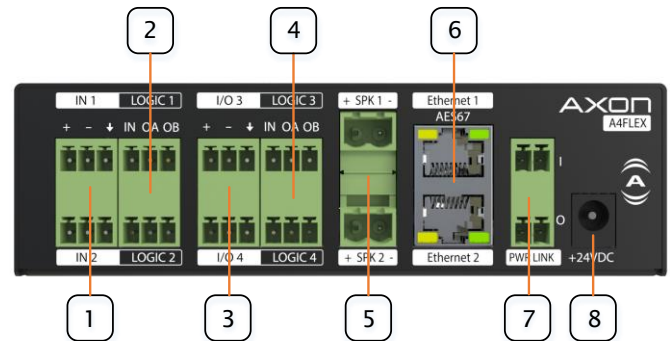

	Description
1	Balanced mic/line inputs (Channels 1 and 2)
2	Logic inputs 1 and 2 / Logic outputs 1A/1B and 2A/2B
3	Flex I/O (Channels 3 and 4)
4	Logic inputs 3 and 4 / Logic outputs 3A/3B and 4A/4B
5	Amplifier outputs 1 and 2
6	Ethernet interface connectors and indicators
7	Power link connections for +24V DC power daisy chaining
8	DC input jack (center positive)

2 Product Installation

2.1 - Mounting

The A4FLEX has provides flexible mounting options:

- **Unit Surface Mounting**- The A4FLEX is supplied with two “L”-shaped mounting brackets that can be attached to either side of the unit. Once fitted, these brackets can be used to secure the A4FLEX to any a flat surface. The brackets can be fitted with the flange facing up or down which allows the unit to be fitted under a desk for example.



2 - Under Table Surface Mounting

Installation Mounting Template

An installation mounting template is provided to simplify the process of installing the A4FLEX in surface mount configuration.

These templates can be [downloaded here](#).

- **Rack Mounting** - The A4FLEX is a 1/3 rack width device and 1RU high. It can be mounted into a rack using the rack tray accessory (*sold separately*). The accessory tray can hold up to three 1/3rd rack width AXON units.

When used with the rack shelf, the A4FLEX is attached to the tray with mounting screws installed through its base. The “L” brackets are then used as the rack ears by installing them to the side flanges of the tray.



3 - Rack Mount Tray

- **Tray Surface Mounting**

The tray accessory may also be installed in a surface mount orientation. In this configuration, brackets are installed along the upper lip of on the sides of tray, allowing it to be mounted on any flat surface thus allowing multiple units to be installed easily on a wall or under a table too.



4 - Tray Surface Mounting Configuration

**Note: Complete CAD drawings can be downloaded from the QSC website. Please contact QSC tech support for any further product related information that is not accessible on the website.*

2.2 – Power & Network Connectivity

The A4FLEX can be powered using either PoE, PoE+, or a 24V power supply attach to the power jack input.

When powering using PoE or PoE+:

- Attach the Ethernet 1 port to a PoE-enabled port on a PoE switch or midspan injector using a CAT-5e or better cabling.

When powering using an optional external supply:

- Attach either Ethernet port to a port on the audio network switch using a CAT-5e or better cable.
- Attach the power supply to the power input jack and then power up the external supply.

**Note: Use of the audio amplifier outputs is prevented when powering from PoE. It is therefore recommended to use either PoE+ or a separate 24V supply in order to get full output power. Internal audio limiting is applied when PoE+ power is detected as the power source in order to prevent over-current conditions on the PoE+ PSE.*

2.2.1 - Daisy Chain Switched Configuration

By default, the Ethernet ports on an A4FLEX act as a two-port switch. This be useful if, for example, there is a second unit in the same physical location as the A4FLEX. Its network can be connected to the A4FLEX instead of having to have a separate home run back to the switch thus creating a daisy chain saving time and cabling and network infrastructure costs.

Daisy Chain Power Constraints

PWR Link – The Power Link connectors provide quick access to a 24V DC power source to enable daisy chain powering configurations. Power can be supplied to a daisy chain device by wiring the power link connector on the A4FLEX to the power link connector on the daisy chained device.

Use of the PWR Link daisy chain connectivity is not recommended if the internal audio amplifiers are intended to be used.

Note: The PWR Link connectors are powered from the DC input jack. These connections are not fused and care should be taken not to overload the external power supply when daisy chaining units using the PWR Link connection.

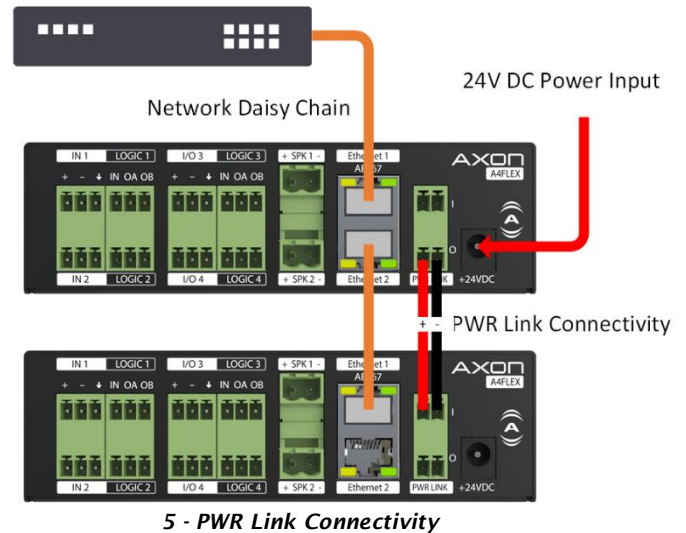

2.2.2 - Independent VLAN Configuration

The Ethernet network ports can also be configured as independent VLANs. This allows the A4FLEX to support applications where the audio network and control network are run in their own individual VLANs. "Ethernet 1" would always be the audio connection while "Ethernet 2" would be the control network connection.

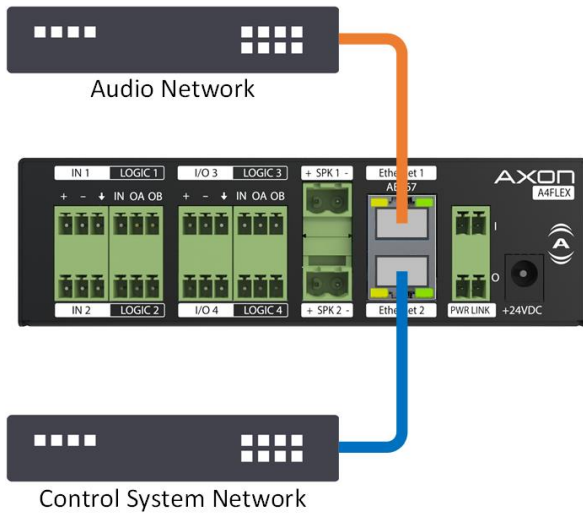

6 - Independent VLAN Configuration

***Note:** All Attero Tech by QSC products are tested using UTP network cabling and it is recommended that UTP cabling be used when installing them. STP cabling can be used for installation though care must be taken not introduce grounding issues into the system by doing so.

2.3 - Audio I/O Connections

The A4FLEX features two dedicated audio inputs, two flexible I/O that can be configured as audio inputs or outputs, and two dedicated amplified outputs.

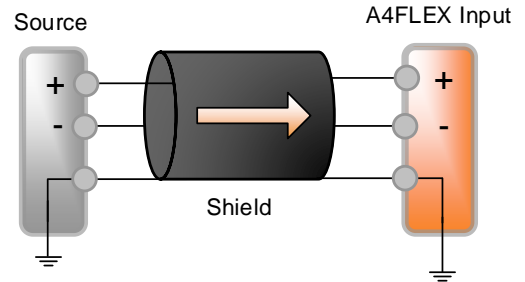

7 - Balanced Wiring Example

The audio inputs and outputs use a balanced connection. If connecting to devices that have unbalanced connections, the wiring should be done as follows:

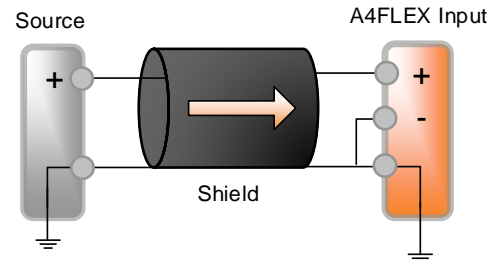

8 - Unbalanced to Balanced Wiring Example

The amplified outputs are designed to drive low impedance 4 and 8 ohms speakers. The SPKR connections on the A4FLEX should be wired direct to the speaker terminals.

NOTES:

- * Make sure suitable speaker cable is used.
- * The A4FLEX does not support bridging of the speaker outputs

2.4 – LED Status Indications

The A4FLEX is equipped with various LED indicators. The following chart indicates the available LED status information:

LED	Device Status	Status Indication (LED)
Multiple	Booting	Solid Yellow (PWR / NET / USB / I/O LEDs)
	Critical error	Slow Blink Red (PWR / NET / USB / I/O LEDs)
	“Identify” mode	Slow Blink White (PWR / NET / USB / I/O LEDs)
	Firmware Update	Fast Blink Blue (PWR / NET / USB / I/O LEDs)
PWR	Power on (OK)	White
NET	No PTP sync	Solid Red
	PTP sync – Slave	Solid Green
	PTP sync - Master	Solid White
USB	USB Host Connected	White (USB LED)
I/O	Ch1-Ch4 Input	Off
	Ch1-Ch3 Input, Ch4 Output	Green
	Ch1,2 and 4 Input, Ch 3 Output	Blue
	Ch1-Ch2 Input, Ch3-Ch4 Output	White
SIG	Signal below - 60dBFS	Off
	Signal between - 60dBFS and - 20dBFS	Green
	Signal between - 20dBFS and - 3dBFS	Yellow
	Signal above - 3dBFS	Red

9 - Status Indicators

3 – Device Configuration

The A4FLEX product is supported for setup and monitoring within Attero Tech by QSC’s unIFY Control Panel software. Additionally, QSYS Designer plugins are available to provide seamless integration with the QSYS DSP platform.

For a complete description of the A4FLEX software controlled features found in unIFY Control Panel and API documentation, please refer to the Documents section of the [Axon A4FLEX product page](#) on the QSC website.

3.1 – IP Address Setup

***** **IMPORTANT** *****
Failure to correctly configure IP addresses will not allow an A4FLEX device to correctly authenticate in the unIFY Control Panel software, and configuration and control to and from the A4FLEX will not be possible.

In order to configure an A4FLEX or to update A4FLEX firmware, a PC will need to be able to communicate with it over the network. While all A4FLEX devices will be discovered regardless of the IP address setup on the PC (the A4FLEX utilizes mDNS for device discovery), full communication can only occur if the PC and the device have compatible IP addresses.

By default, A4FLEX is set to get a dynamic IP address. If the A4FLEX device does not find a DHCP server to retrieve an IP address from, it will give itself a local link address (sometimes also known as an automatic private IP address or APIPA) instead. A local link address is always in the range 169.254.x.y.

To ensure communication, the PC can either be also set to get a dynamic IP address, or be given a static IP address in the range 169.254.x.y. In some cases the PC

3.2– Networking Information

The A4FLEX uses the following IP addresses, services and ports for communications on the network.

Port	TCP / UDP	Multicast IP	Description
68	UDP	N/A	DHCP
5353	UDP	224.0.0.251	mDNS – Device Discovery
319-320	UDP	224.0.1.129	PTP – Clocking (Domain 0)
49494	UDP	N/A	A4FLEX control
49495	UDP	239.255.255.255	A4FLEX status and metering

10 - Ports and Protocols

3.3 – Audio I/O and DSP Setup

All audio input, output and internal audio DSP setting may be configured through unIFY Control Panel.

Each analog audio input features switchable +48V phantom power, mic/line pad and supports up to 42 dB of adjustable preamp gain in 1 dB steps.

Each analog line output has a switchable pad allowing the output to be either at either mic or line level.

The internal audio DSP features basic audio processing as shown in the diagram below.

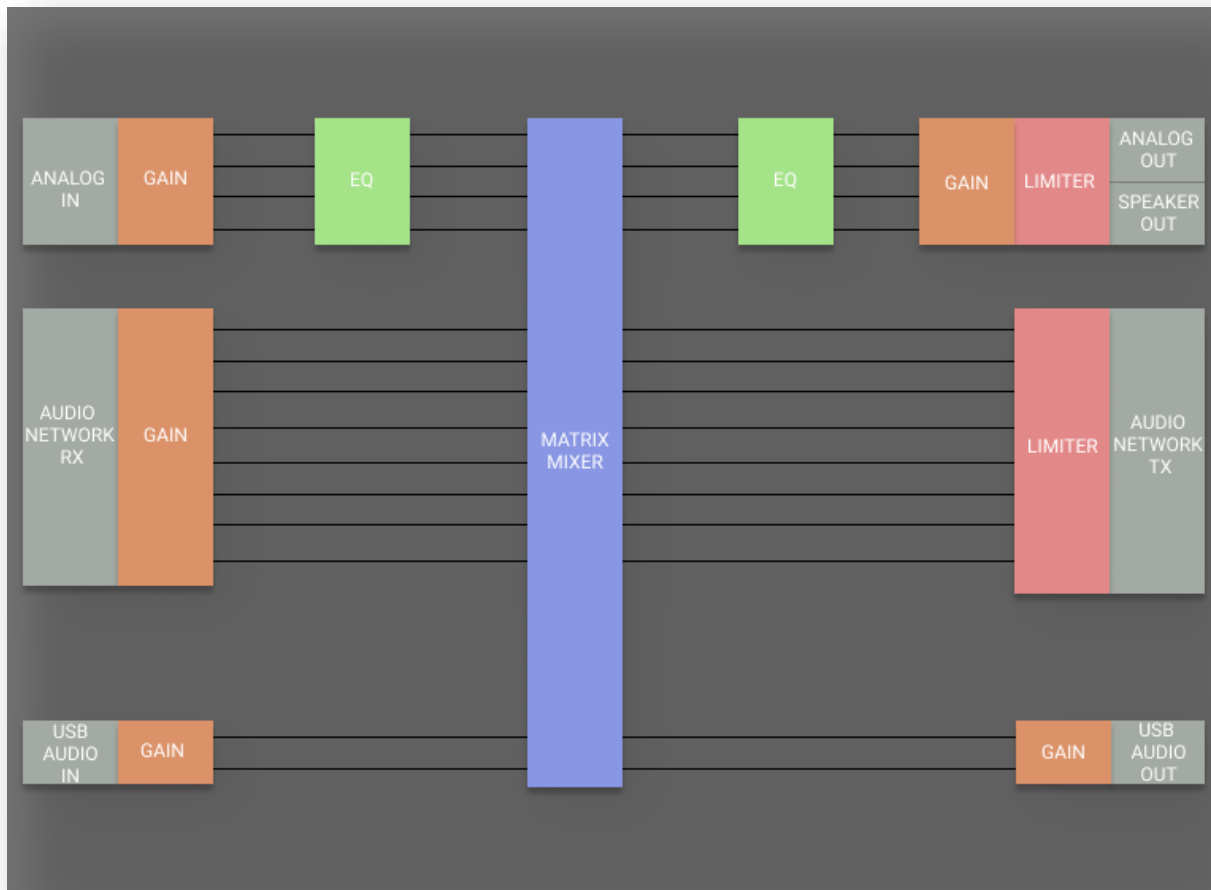

11 - DSP Signal Flow Diagram

3.4 - Logic I/O Setup

The A4FLEX features four logic inputs. Each logic input also has two associated logic outputs, labeled as A and B.

The logic inputs are open collector inputs, and designed to be interfaced directly with mechanical switches or 3.3V logic devices and are 5V tolerant.

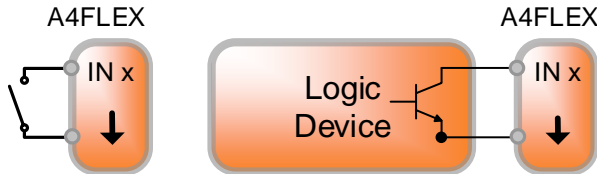

12 - Logic Input Connectivity

The logic outputs may be used to directly drive attached LEDs (up to 10mA @ 3V)

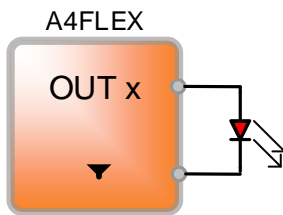

13 - Logic Output LED Connectivity

Alternatively, the logic outputs may be used in a sinking configuration. Either the PWR link output may be used to source a 24V supply voltage to the attached device, or an external supply is provided up to 24V DC, while maintaining a common ground between devices. The maximum sinking current in this configuration is 50mA.

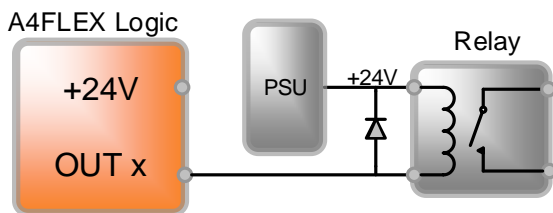
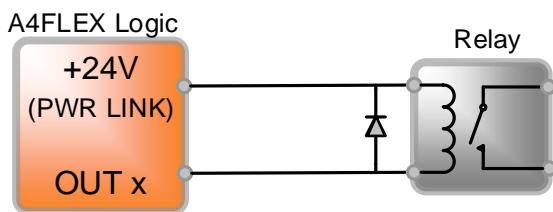

14 - Logic Output Sinking Configuration

The logic inputs can be polled to obtain their state. However, the A4FLEX also supports asynchronous logic event messages that

are triggered when the logic input changes state. Each input supports an "input high" event message and an "input low" event message. The A4FLEX can be configured to send just "input Low" messages, just "input high:" messages or both low and high messages.

3.5 - Factory Reset

***** IMPORTANT *****
The factory reset returns the entire device to its factory defaults. Using this feature will mean all custom settings will be cleared.

**NOTE: The factory reset is a useful way of quickly restoring communications with a device which has an unknown static IP address, as a factory reset returns the device's network settings to getting a dynamic IP. Having successfully completed a factory reset of the device, setting the PC's IP address to also obtain a dynamic IP address should then allow the PC to communicate fully with that device.*

The factory reset button is accessed through a small hole on the front of the unit using a small screwdriver or a paperclip. A factory reset is initiated by pressing and holding this button for 5 seconds or more while the device is running and then releasing it. If done correctly, a second or two after the button is released, all SIG indicators will turn off and the PWR, USB, NET and I/O indicators will all turn yellow as the device reboots and it will then go through a normal start-up procedure. If the indicators do not change a couple of seconds after releasing the button, that is an indication the reset button not being held long enough and the factory reset was not applied.

Having applied a successful factory reset, on the network side, any customized settings such as device name, stream names and stream IP addresses, as well as receive stream assignment will all be set back to their defaults. The device will also revert to retrieving an IP address dynamically. The power-up defaults for the audio settings are also cleared.

3.6 - Firmware Updates

The A4FLEX supports field firmware updates. The updates are applied via the network using the smart firmware update tool within the Attero Tech by QSC unIFY Control Panel. This software is available on the [QSC website](#). The latest A4FLEX firmware file is available from the [Attero Tech firmware page](#) on the QSC website.

4 – ARCHITECTS & ENGINEERS SPECIFICATION

The networked audio interface shall provide the ability to interface up to 4 microphone or line-level inputs to an AES67 audio network and remote AES67 enabled audio devices.

Two of the mic/line inputs shall support selectable direction via software.

The device shall also provide 2 speaker level outputs for driving low impedance speakers.

The device shall support an integrated Ethernet switch for daisy chain connectivity to additional units via the network, as well as the option to daisy chain DC power.

The device shall provide 4 5V tolerant, 3.3V level open collector logic inputs, with 8 logic outputs for driving external LEDs or logic controlled devices.

The device shall provide the ability to interface USB digital audio from a connected device to and from an AES67 network.

The AES67 networked audio interface shall support transmission and reception of 8 independent channels in both directions at 48 kHz, 24-bit with 1 ms packet times.

Internal DSP on the device shall support signal mixing of all I/O, equalization and output limiting.

The device shall support surface mounting and rack mounting with optional accessories.

The unit shall accept either IEEE 802.3af/802.3-at standard PoE/PoE+ from an IEEE 802.3af/at PoE/PoE+ compliant network switch or mid-span injector.

The unit shall include a software plugin for simple interfacing with QSC Q-SYS based DSP systems.

The network control interface shall be compliant with the RoHS, WEEE and REACH directives.

The network control interface unit shall be Compliant with the EMC/ESD requirements for FCC and CE.

The unit shall be the Attero Tech, Axon A4FLEX product.

Device Specifications

Audio Inputs (Mic/Line)	
Connector Type	3.81 mm Euro-block, 3 position (16-28 AWG)
Gain	-8 dB to +34 dB gain, 1 dB increments
Input Impedance	>2K ohms at any gain
Maximum Input Levels	-8 dB Gain, max input = +16.5 dBu (+24 dBu w/pad),
Phantom Power:	+48V, software selectable per channel
THD+N	<0.05% @ 1 kHz, -3 dBFS input. 20-20kHz
Frequency Response	20-20 kHz, +/- 1 dB (Line), 50-20kHz +/- 1 dB (Mic)
EIN	-125 dBu
Audio Line Outputs	
Connector Type	3.81 mm Euro-block, 3 position (16-28 AWG)
Maximum Output Levels	+24 dBu (-15.5 dBu w/pad)
Phantom Power:	+48V, software selectable per channel
THD+N	<0.05% @ 1 kHz, -3 dBFS input. 20-20kHz
Frequency Response	20-20 kHz, +/- 1 dB (Line), 50-20kHz +/- 1 dB (Mic)
Dynamic Range	100 dB
Speaker Outputs	
Connector Type	5.08mm Euro-block 2-position (12-24 AWG)
Output Power	2 x 10 W (DC Input), 2 x 5W (PoE+) into 4 Ohms
THD+N	<0.5% @ max power (measured at 1kHz)
Frequency Response	20-20kHz
Logic I/O	
Connector Type	3.81 mm Euro-block, 3 position
Logic Inputs	4 Inputs, 0 to 3.3V input voltage range, software configurable for analog or digital operational modes
Logic Outputs	8 Outputs, 50mA sinking capability (5V - 24V external supply), 10mA @ 3V sourcing capability
USB Audio	
Connector Type	Mini USB-B
USB Audio Support	1x1, 2x2 USB Audi 2.0, 44.1/48k kHz, 16/24 bit

Network	
Physical Layer	Ethernet
Connector (s)	Dual RJ-45
Cable Quality	CAT-5e or better, UTP
Transmission Speed	1 Gbps
AES67 Audio Network	
Stream Announcement	SAP
Sample Rate	48 kHz, 24 bit
Packet Times / Latency	1 ms / <2ms receive latency
Power Specifications	
PoE Power	802.3af/at Class 0
Power Consumption	<8W, (typical quiescent power w/o amplification and logic device attached) < 30W Max on PoE+, <12.95W on PoE
Power Options	PoE, +24VDC on PWR LINK inputs or +24VDC on 2.1 mm jack (PoE and external DC can be used for redundancy) <ul style="list-style-type: none"> PoE pass-through supported w/software option on Ethernet 2 port
Physical Dimensions	
Height	1.6"
Width	5.394"
Depth	7.88"
Weight	1.82 lbs.
Regulatory Compliance	
Certifications	FCC Part 15, Subpart B, Class A EMC CE (EN55032 EMC / EN55035 ESD) WEEE RoHS REACH
Environmental Operating Specifications	
Operating Temperature	0 to 40° C